



Officina.

OASIS_OPERATIVE

OASIS_OPERATIVE

Contenitori free-standing attrezzati ed accessoriati, concepiti per diventare isole di lavoro in grandi spazi comuni, dove isolarsi o interagire, individuando la postazione più consona alla necessità lavorativa del momento.

Freestanding cabinets, racks and shelves are fully equipped and accessorized, conceptualized to become work islands within large common areas, where one can be isolated or integrated, identifying the place that fits the most into the work needs of the moment.

Samostojeći ormani i komode, potpuno opremljeni i sa svim dodatnim elementima, osmišljeni su kao radna ostrva u zajedničkom velikom prostoru, gde je moguće izolovati se ali se i integrisati, tako što će se odabrati položaj koji najviše odgovara radnim potrebama u datom trenutku.





Contenitore altezza 740 mm.
Cabinet height 740 mm.
Visina ormarića 740mm.





Contenitore altezza 1300 mm.
Cabinet height 1300 mm.
Visina ormara 1300 mm.



Contenitore altezza 1700 mm.
Cabinet height 1700 mm.
Visina ormara 1700 mm.



FINITURE / FINISHES / ZAVRŠNA OBRADA

STRUTTURE / CORPUS / KORPUS

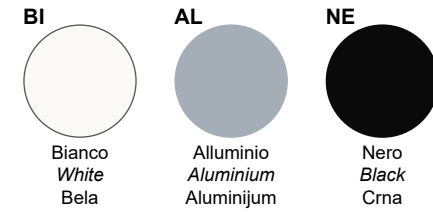

TOP / TOPS / PLAFON

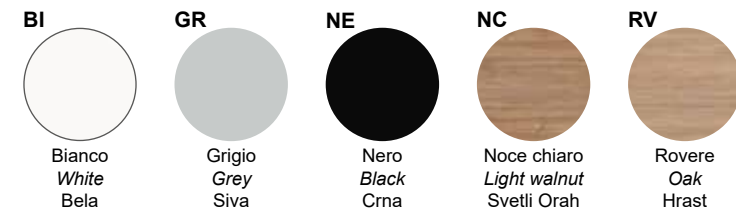

FRONTALI / FRONTALS / LICA

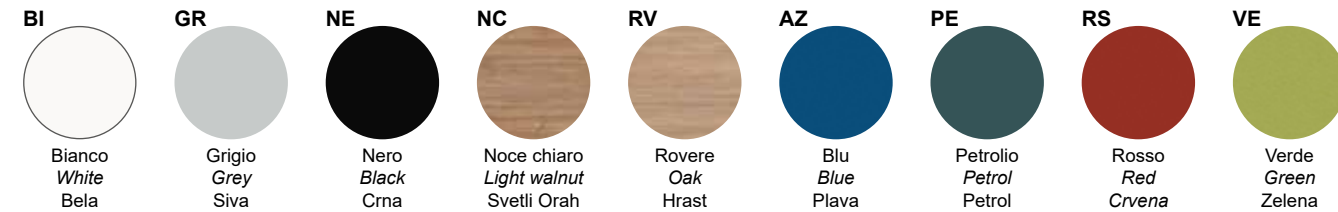

CUSCINI / CUCHIONS / JASTUCI

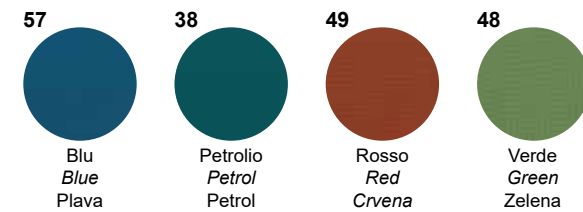

ABACO / ABACUS / ABAKUS

CONTENITORI LATERALI / SIDE CABINETS / BOČNI ORMAR

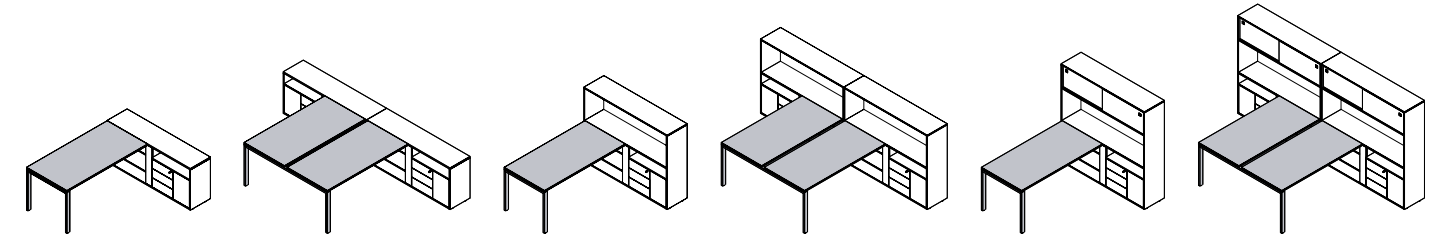

L = 1650 mm
P = 398 mm
H = 740 / 1300 / 1700 mm

CONTENITORI CONDIVISI / SHARED CABINETS / DELJENI ORMAR

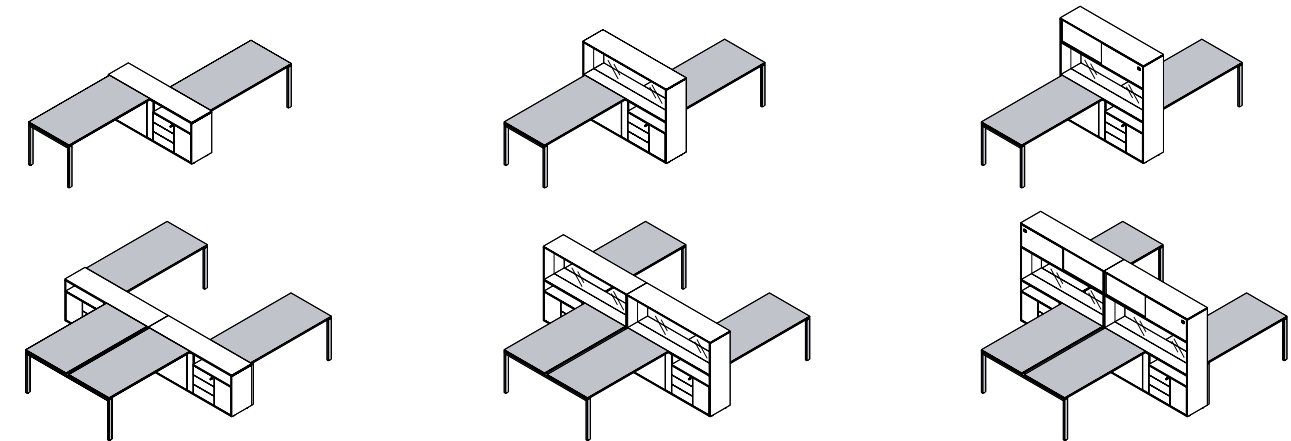

L = 1650 mm
P = 398 mm
H = 740 / 1300 / 1700 mm

CONTENITORI / CABINETS / ORMAR

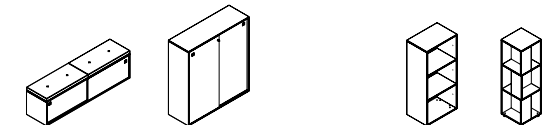

L = 1200 / 1650 mm
P = 398 mm
H = 500 / 1300 mm

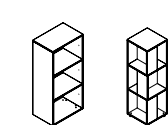

L = 398 / 600 mm
P = 398 mm
H = 1300 mm

L'Azienda si riserva il diritto di apportare, senza preavviso, modifiche dimensionali, estetiche e tecniche ai prodotti.

The Company reserves the right to introduce changes to products sizes, aesthetical or technical aspects at any time without notice.

Kompanija zadržava pravo da u bilo kom trenutku bez najave, uvede promene u dimenzijama proizvoda, kao i promene estetskih ili tehničkih aspekata proizvoda.



Officina.

Officina Concept d.o.o.
Kablovska 13D
35000 Jagodina - Serbia
T +381 035 8150006
www.officinaconcept.com
sales@officinaconcept.com